

AWA RT85  
&  
Midland 70-066  
Conversion  
To  
6 Meters

Ver 1.5 – 29 Jan 2009

Part 2

Rod McCosker VK2DOT

# **AWA RT85 & Midland 70-066 low Band Conversion to 6 Meters:**

## **Index:**

### **Part 1:**

Acknowledgment:  
Modifications:  
Parts Needed:  
Test Equipment needed.  
Information about AWA RT-85.  
Information about Midland 70-066  
6 Meter AWA RT85 & Midland 70-066 FM Frequencies – 62 channel EPROM.  
6 Meter AWA RT85 FM Frequencies – 10 channel EPROM.  
6 Meter AWA RT85 & Midland FM Frequencies – Rx only for F calls & non licensed amateurs.  
Using the Club's De-soldering Station.  
Midland Models:  
EPROM Software:  
The RT-85 Transceiver – Theory of operation.  
The Synthesizer Board including EPROM board.  
Z-273 EPROM Board:  
The VK2DOT Z-273 Adaptor.  
The Synthesizer Board.  
Synthesizer Alignment.

### **Part 2:**

**Receiver RF Front end.**  
**The Receiver Board:**  
**Receiver Alignment.**  
**Transmitter PA Circuit.**  
**The Transmitter PA board.**  
**Transmitter Alignment.**  
**AWA RT85 Receiver Board Top Assembly View**  
**AWA RT85 Receiver Board Bottom Capacitor View:**

### **Part 3:**

The RT-85 Transceiver – Block Diagram  
Receiver Circuit.  
Receiver RF Front End Circuit:  
Transmitter Circuit.  
PA Transmitter Circuit:

## The Receiver Board:

Remove the receiver board from the RT80 Transceiver below.

### **RT85 Receiver Board.**

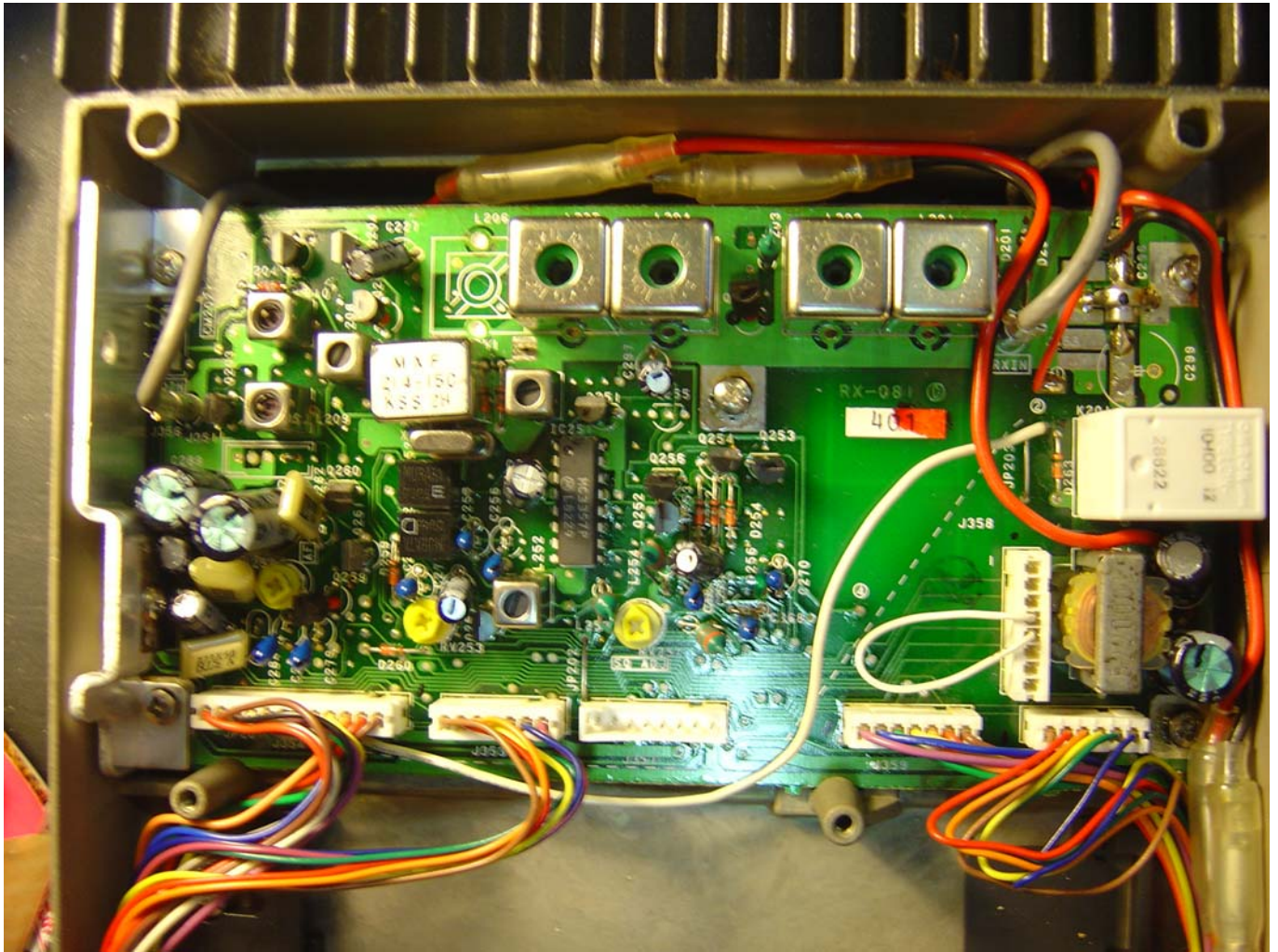



RT80 Receiver Board Bottom below.

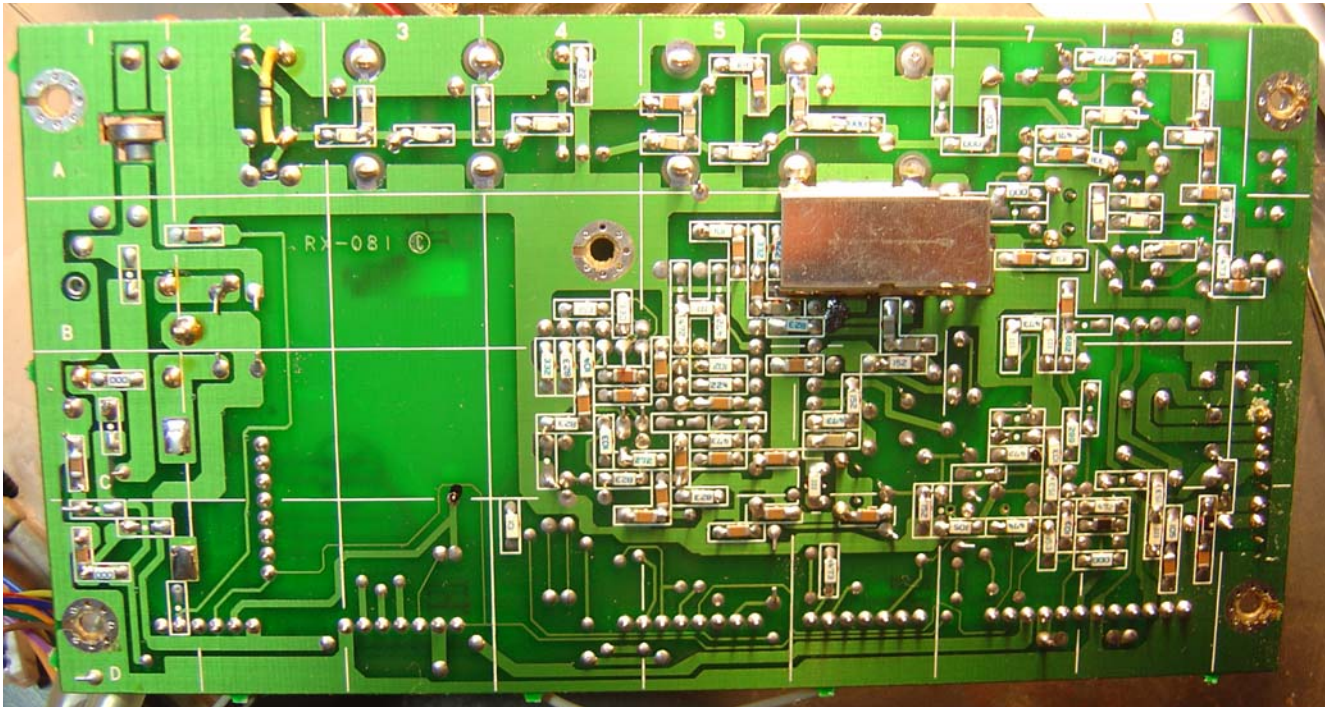

RT85 Receiver Board Bottom Capacitors Added below.

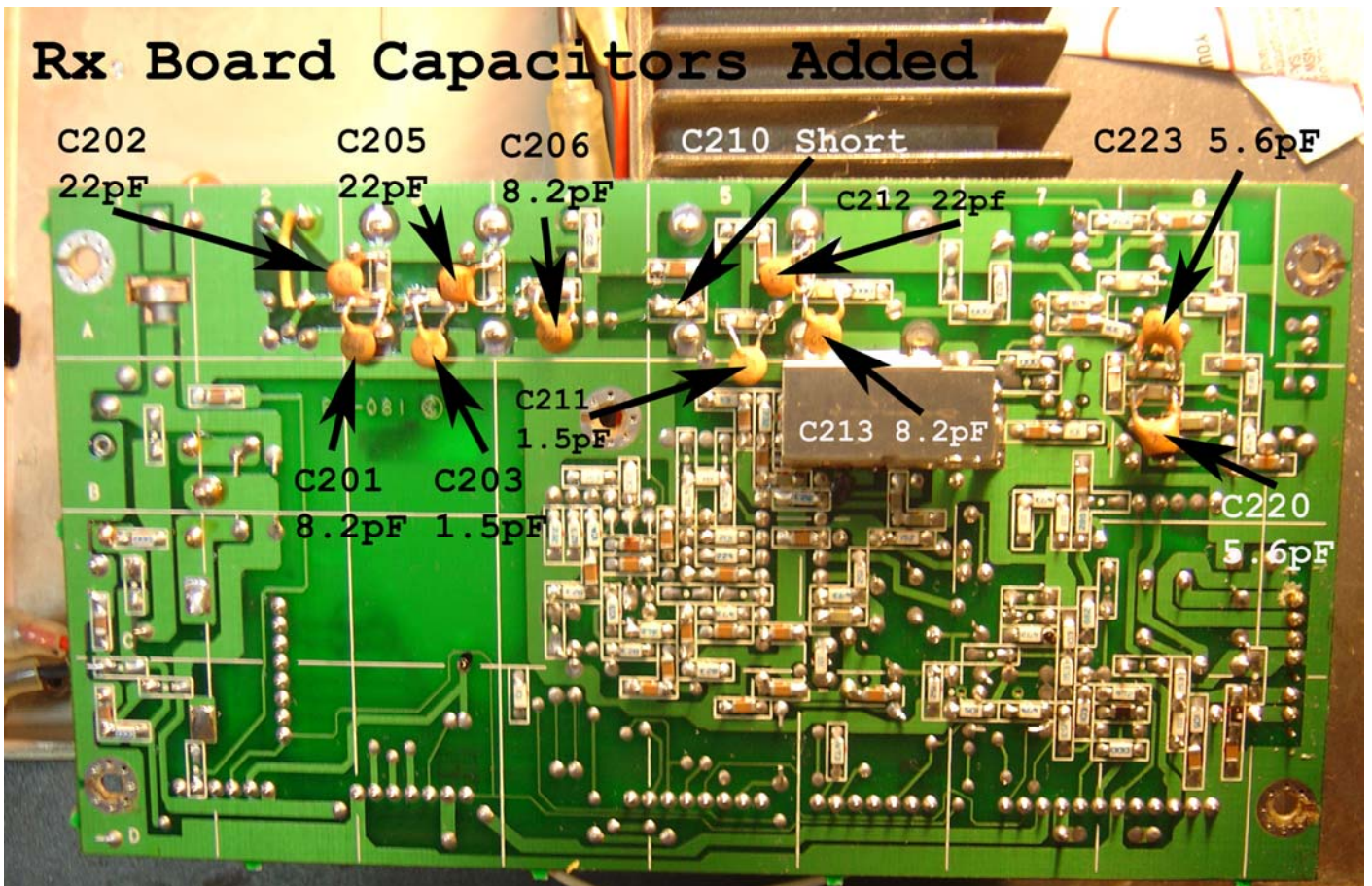

**RT85 Receiver Board Bottom Capacitors below.** [see larger diagram at end for printout]

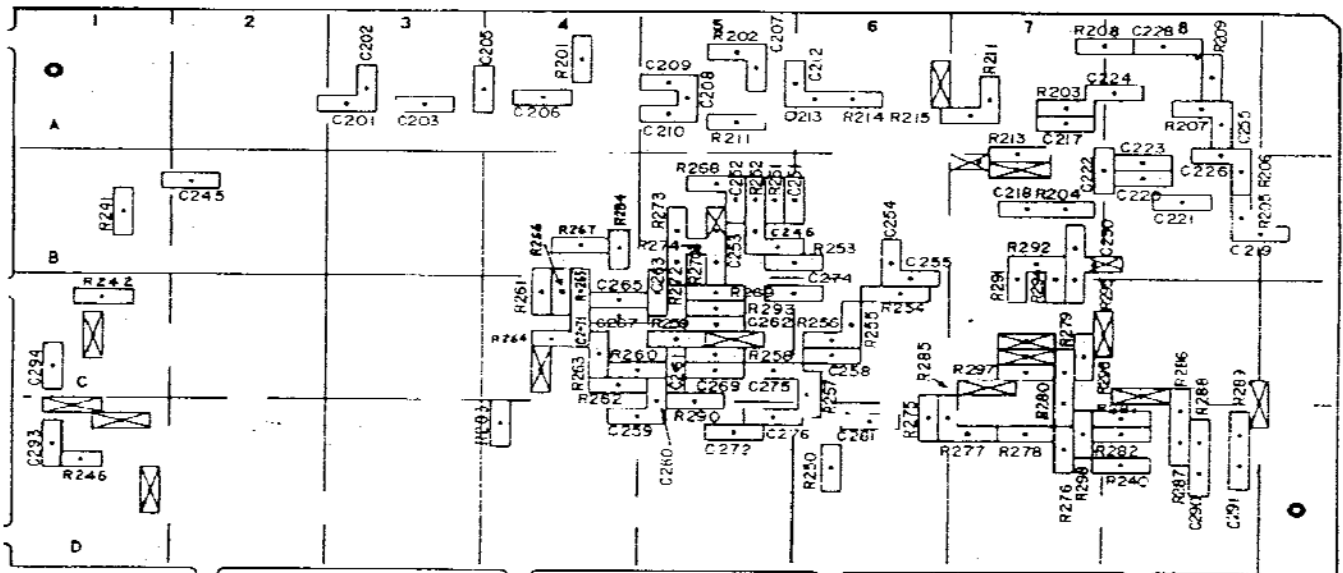

**Rx Front end.** Add 22pF to C202, C205, and C212.  
 Short C210.  
 Add 1.5pF to C203 and C211.  
 Add 8.2pF to C201, C206, and C213.

**LO tuned buffer.** Add 5.6pF to C220 and C223.

**Rx Tune Up.**

Receiver tune up is straight forward. Reconnect the Receiver Local Oscillator J365 to the synthesizer board.

Connect multi-meter or DVM to Monitor CM202 pin 4. Note pin 2 is missing key pin). Switch to center frequency – **Channel 49 - 53.250Mhz** [center between 53.975Mhz and 52.500Mhz.]

To tune the local oscillator multipliers - Adjust L209 and L210 for maximum reading. A typical reading is 0.4 V. A common problem with these transceivers is lack of LO injection if they are not modified and tuned correctly.

Tuning the RF front end - On a mid frequency channel (53.250Mhz) feed a signal in from a signal generator to the RT-85 antenna socket. Connect a multi-meter or DVM to Monitor CM202 pin 3 and peak L201 to L205 for maximum while remaining in the linear range [ie Set signal generator level for positive meter reading before limiting occurs.. Note the reading at this pin will be negative until sufficient RF input signal is available. Repeat adjustments for optimum.

An alternative method is to use a Sinad meter or tune for maximum quieting. When correctly aligned the sensitivity is typically 0.35uV for 12db sinad over the range 52.5 to 54 MHz.



## The Transmitter PA Board:

Transmitter PA Board Top View below.

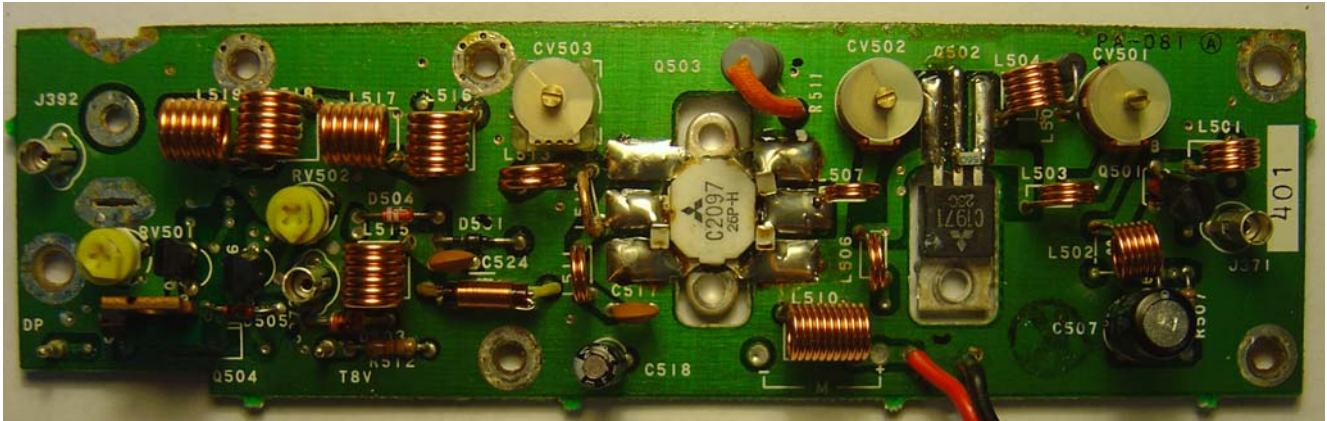

Transmitter PA Board Bottom View below.

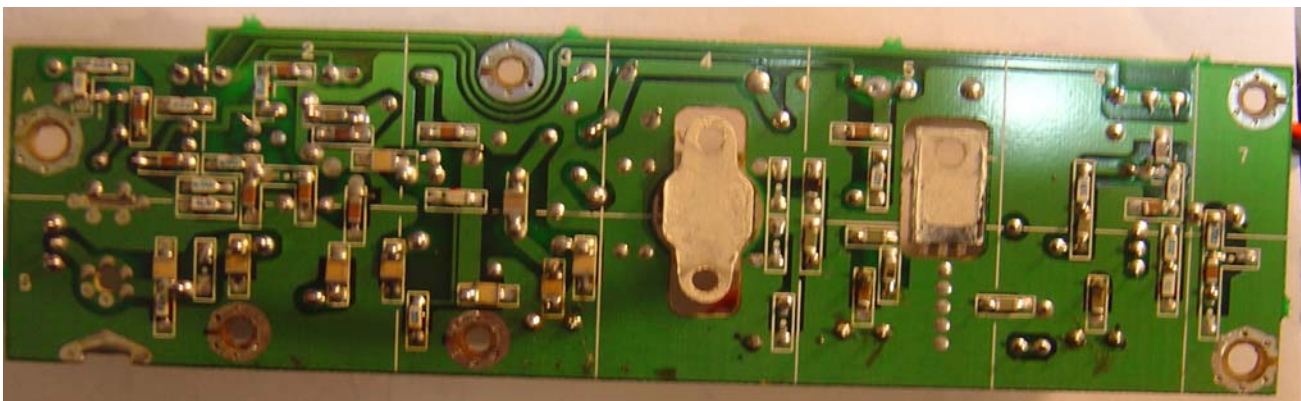

## PA - Remove Coils Completely

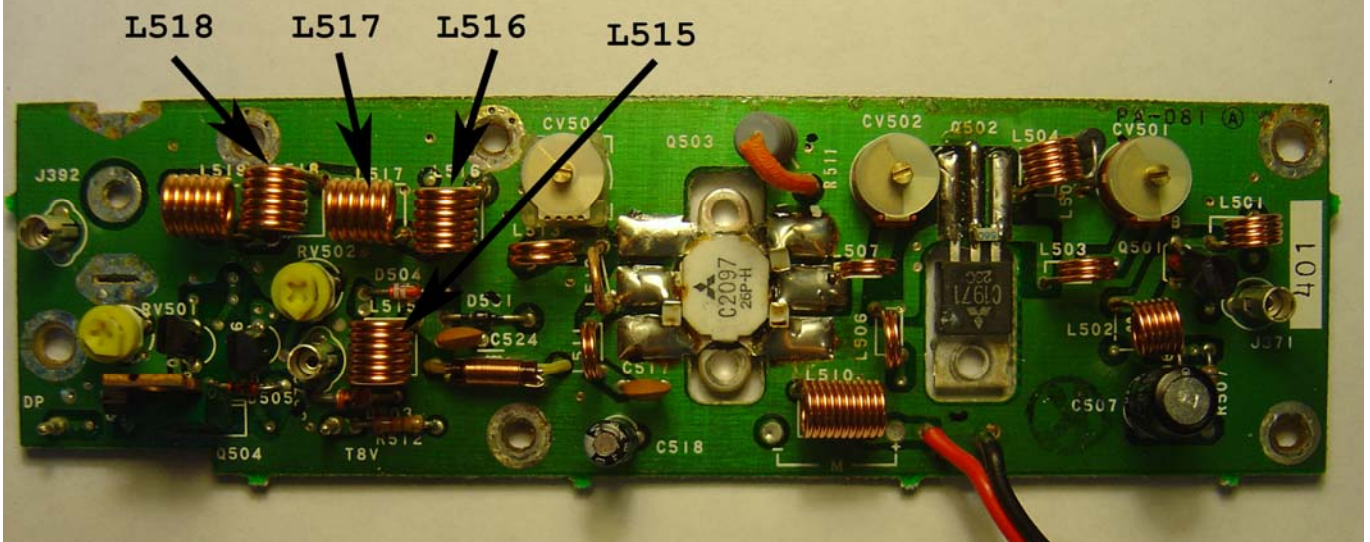

Remove L515, L516, L517 and L518; (**NOTE:** L519 has been removed)

Cut 5 of pieces of 0.63mm [22bs] of enameled coated wire, 143mm long. Scrape off enamel at each end of wire for approximately 5mm. [NOTE: The new Jaycar wire, the enamel will be removed by heat.] Wind onto drill bit [the drill bit should have the same size diameter of the coil retracted from L515]. Each piece of wire should wind for 6.5 turns.

Since these coils will not be reused, use side-cutters to cut them in half and then remove the pieces by heating the joint from the underside and carefully removing the part coil from the top.

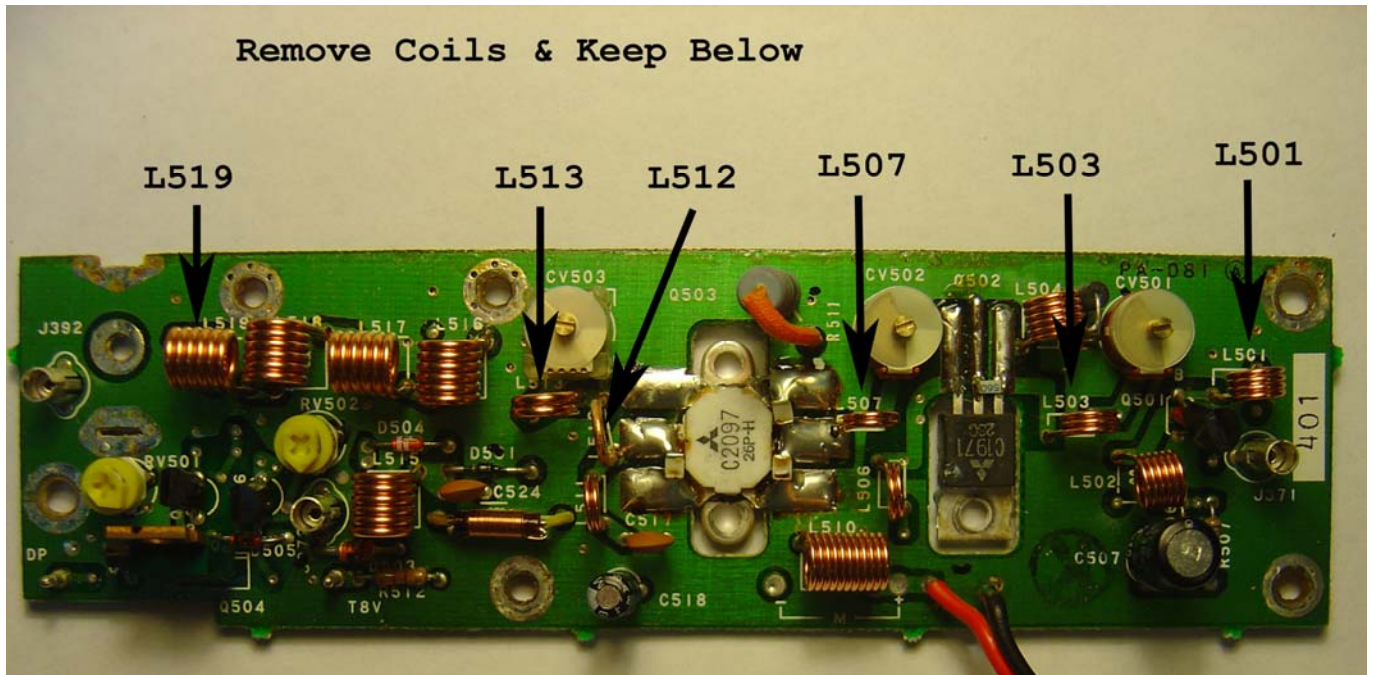

### Tx PA Modifications to 6 Meters:

**Note:** - If you intend to take out all coils in one session [eg using a de-soldering station], before you start to re-solder the coils back in; Then on taking each coil out, tag it with a marker [eg with masking tape] noting the original coil number.

Remove **L501** and keep; replace with original L114 from the synthesizer board.

Remove **L503** and keep; replace with original L501.

Remove **L507**; replace with original L503. [do not keep this coil]

Remove **L519**. Cut back to 2.5 turns and keep coil to replace coil L513.

Remove **L513** and keep; replace with old cut back 2.5 turns of coil L519.

Remove original **L512**; replace with original L513.



# PA Coils Replaced with Coil #

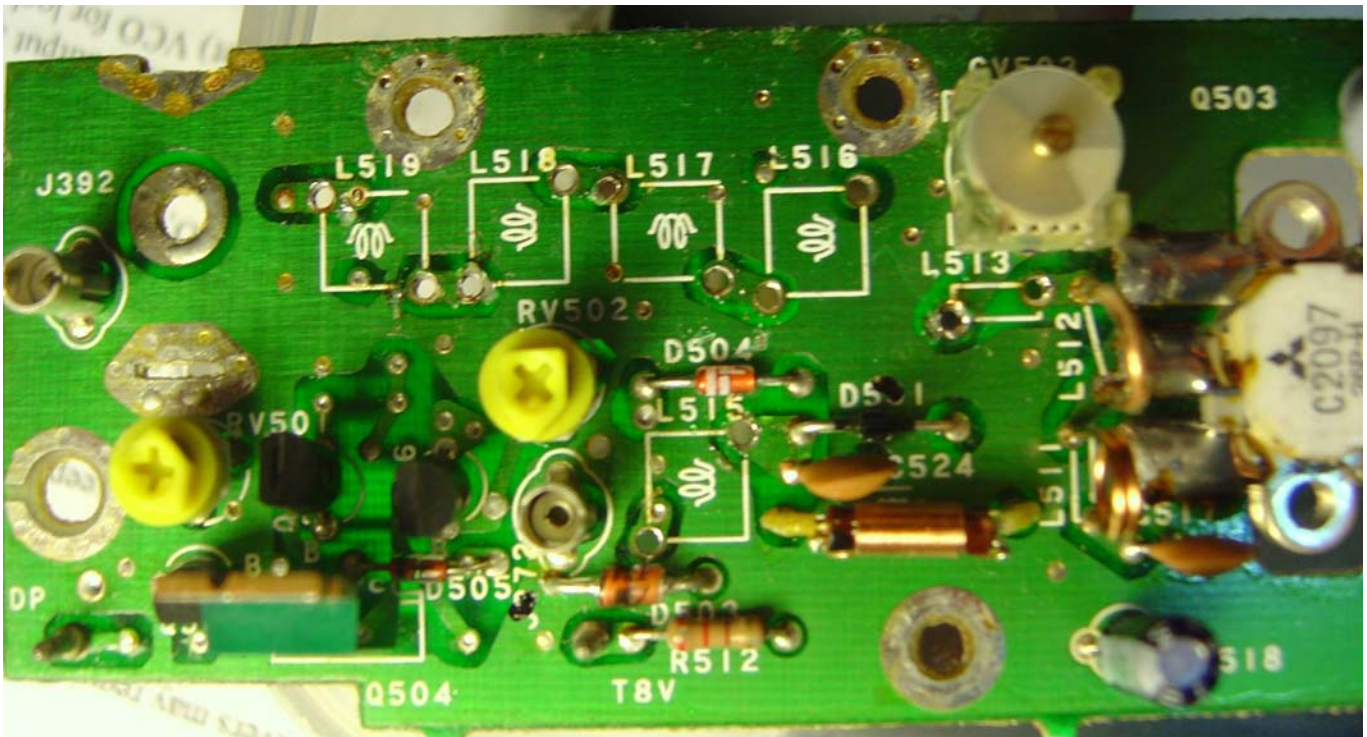
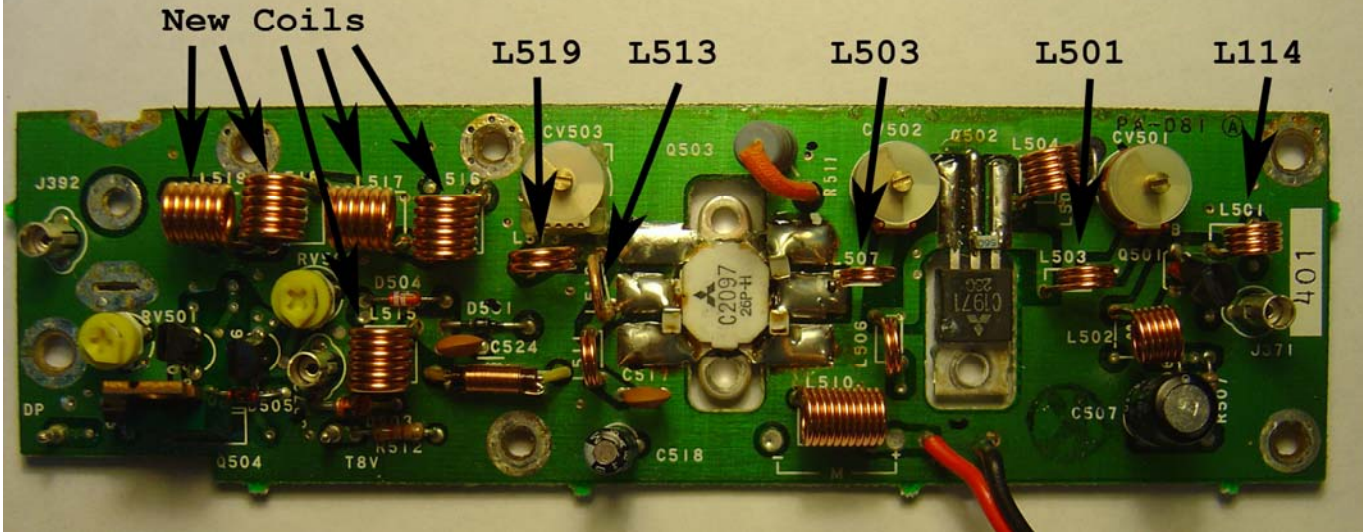



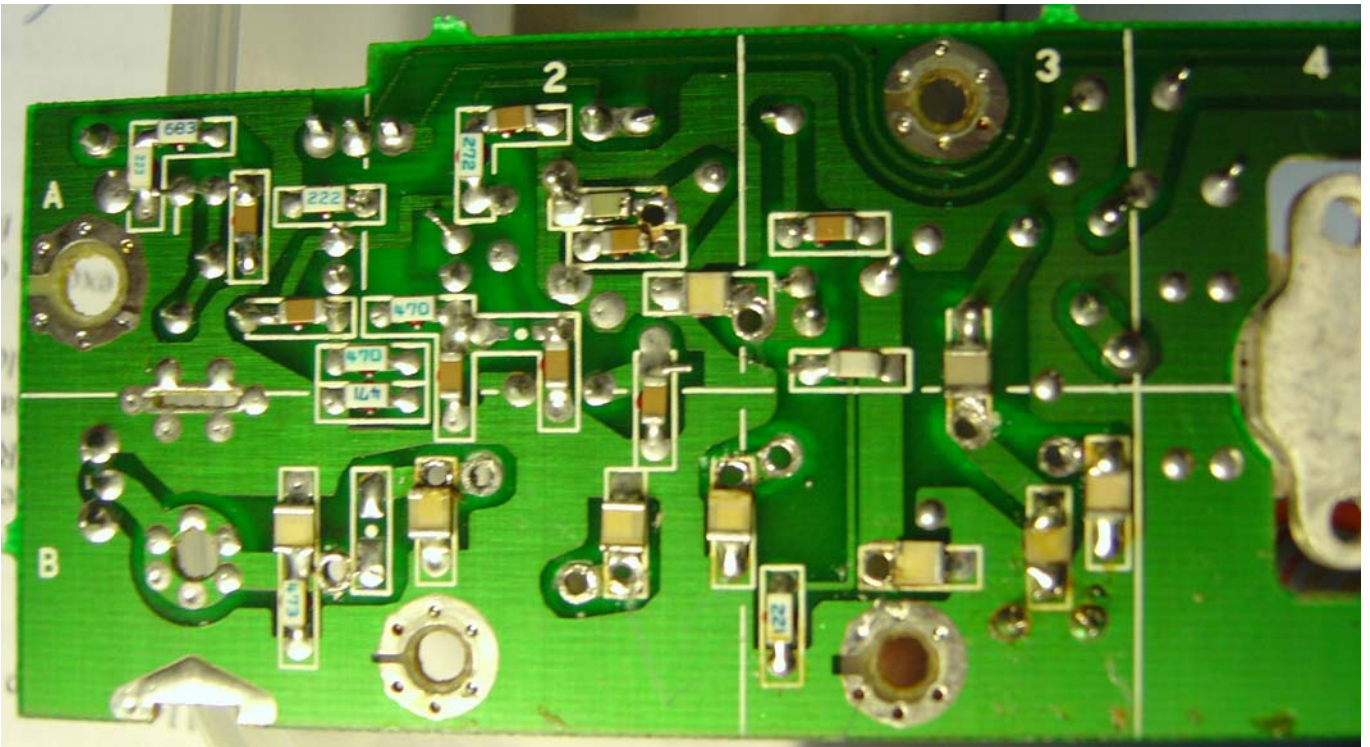

**New Coils placed into PA Board:**

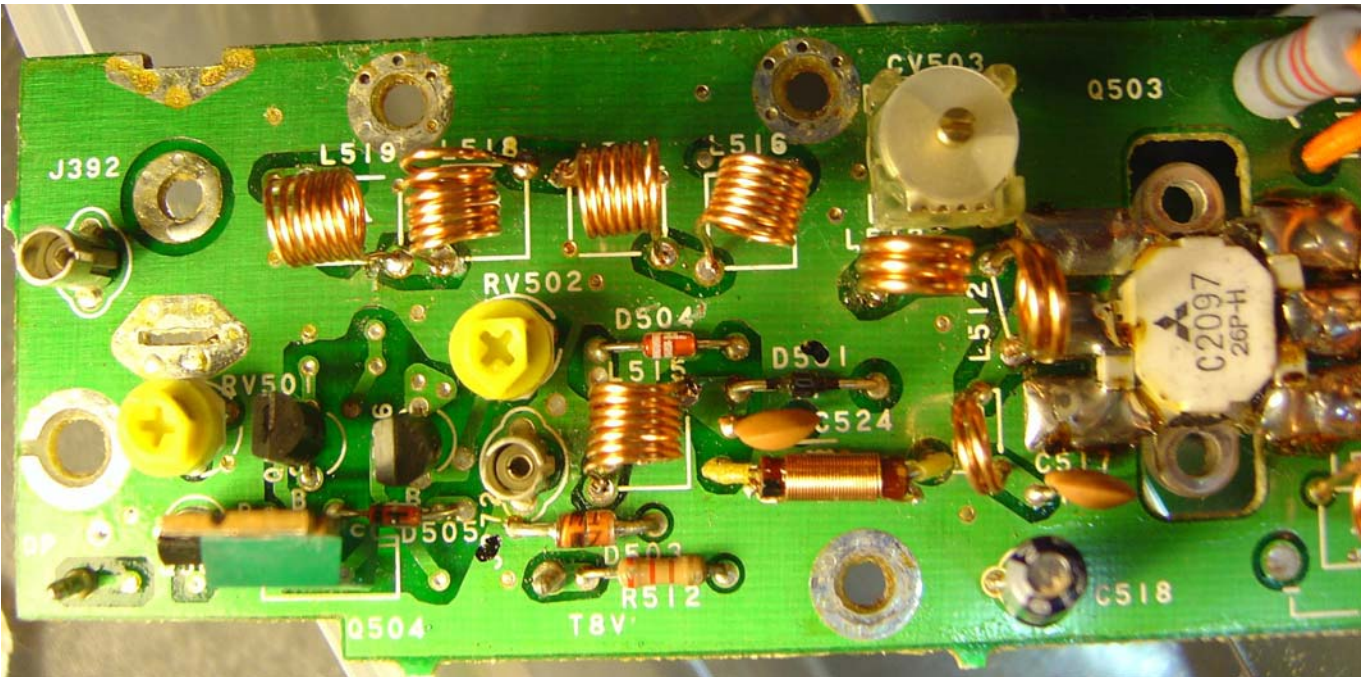



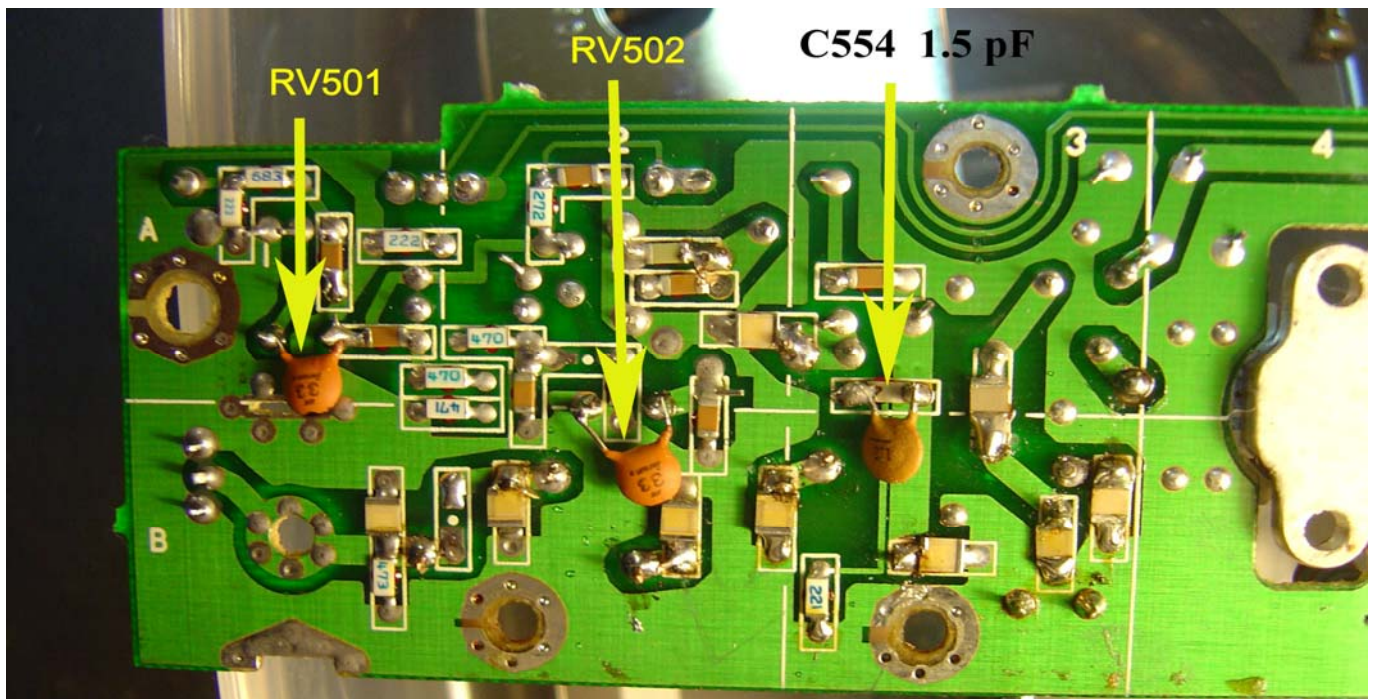

Add 33pF to bottom of RV501 and RV502 on the underside of the board. As photo above.

Add 1.5pF to the RF sensor circuit (C554) on the underside of the board as per the photo. On the RT85 this capacitor is already fitted.

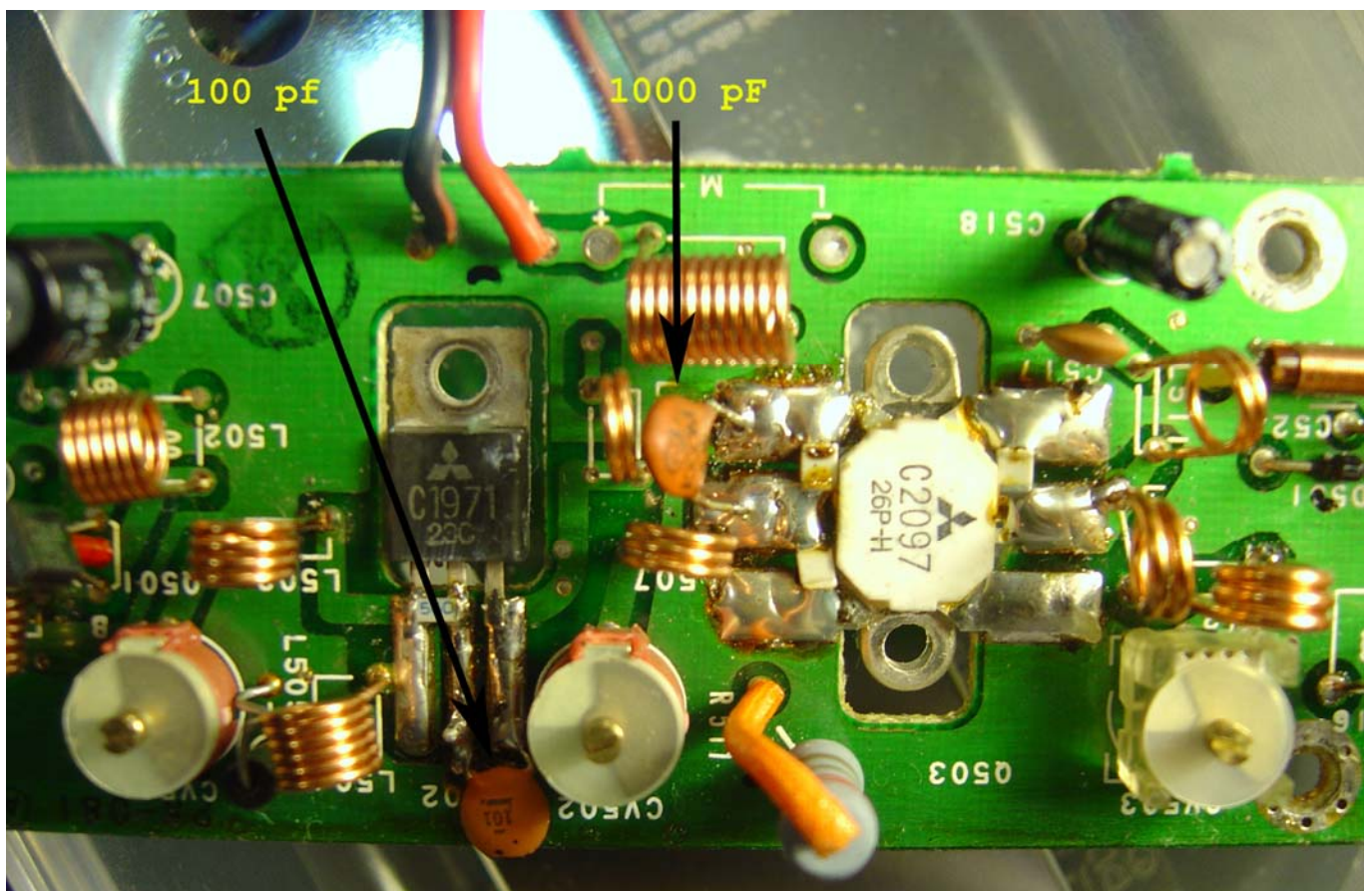

Add 100pF between B and E of Q502 on the component side of the board as per the photo.

Add 1000pF between B and E of Q503 on the component side of the board as per the photo.



Adding the capacitors B-E on the driver and PA transistor is required to stabilize the amplifier. It is necessary to replace the coils in the LPF to get the second harmonic output of the transmitter down to an acceptable level.

Having made the modifications, reassemble the PA and apply power. Terminate the output in a good dummy load with a power meter – **not an antenna!** Set RV502 fully clockwise for maximum power out. Key the transmitter and adjust for maximum power starting from the output end and working back towards the synthesizer. Don't forget CV102 on the synthesizer board. After modification and tuning it is normally possible to get 50W out of the transmitter with no sign of instability, do not run it at this power for long – there is not enough heat sink on the PA. When you have maximum power out adjust RV502 for no more than 30 Watts out. If you wish to run 50 watts, then attach a 12 Volt fan to the rear heat sink. Allow the fan to blow across the rear fins.

## **TRANSMITTER ALIGNMENT**

1. Connect a lower power 50 ohm power meter to J366 [exciter output]. Connect a multimeter to TP101, and operate the microphone PTT button.
2. Adjust L107 such that the multimeter reading is centered on 3.5 Volts for all programmed channels.
3. Adjust CV102 for maximum output into the power meter. output should be 20mW to 40mW (for VHF). Release the PTT button.
4. Connect J366 to P366. Connect the 50W power meter to the antenna output. Set RV502 on the Power Amplifier PCB fully clockwise. Set the power supply to 13.8 Vdc.
5. Operate the PTT and adjust CV501, then CV502, and finally CV503 for maximum power output. Repeat the adjustment of CV501, then CV502 and CV503 for maximum power.
6. Adjust RV502 to obtain  $P_o = 25W$  (High Power position). Note that the power rises slightly as the unit heats up, so adjust for 23 - 24W when cold.
7. If "low power" output is required, short P302 to P303 on the control unit and adjust RV501 for required output.

### **Transmitter Audio Adjustments:**

1. Adjust audio oscillator for a 600 ohm output level of 30mV rms.
2. Switch on the PTT and measure the deviation. Vary the frequency from 500Hz to 3KHz and find the maximum deviation. Adjust RV101 for +- 5KHz maximum, testing for positive and negative deviation. Slight adjustment may be made to L101 and L102 (for VHF) to obtain optimum symmetry and distortion.
3. Reduce the audio oscillator to 3mV rms at 1KHz.
4. Adjust RV102 for +-3KHz deviation. If necessary, repeat steps 1 and 2 above.

**RT85 Receiver Board Top Assembly View - below:**

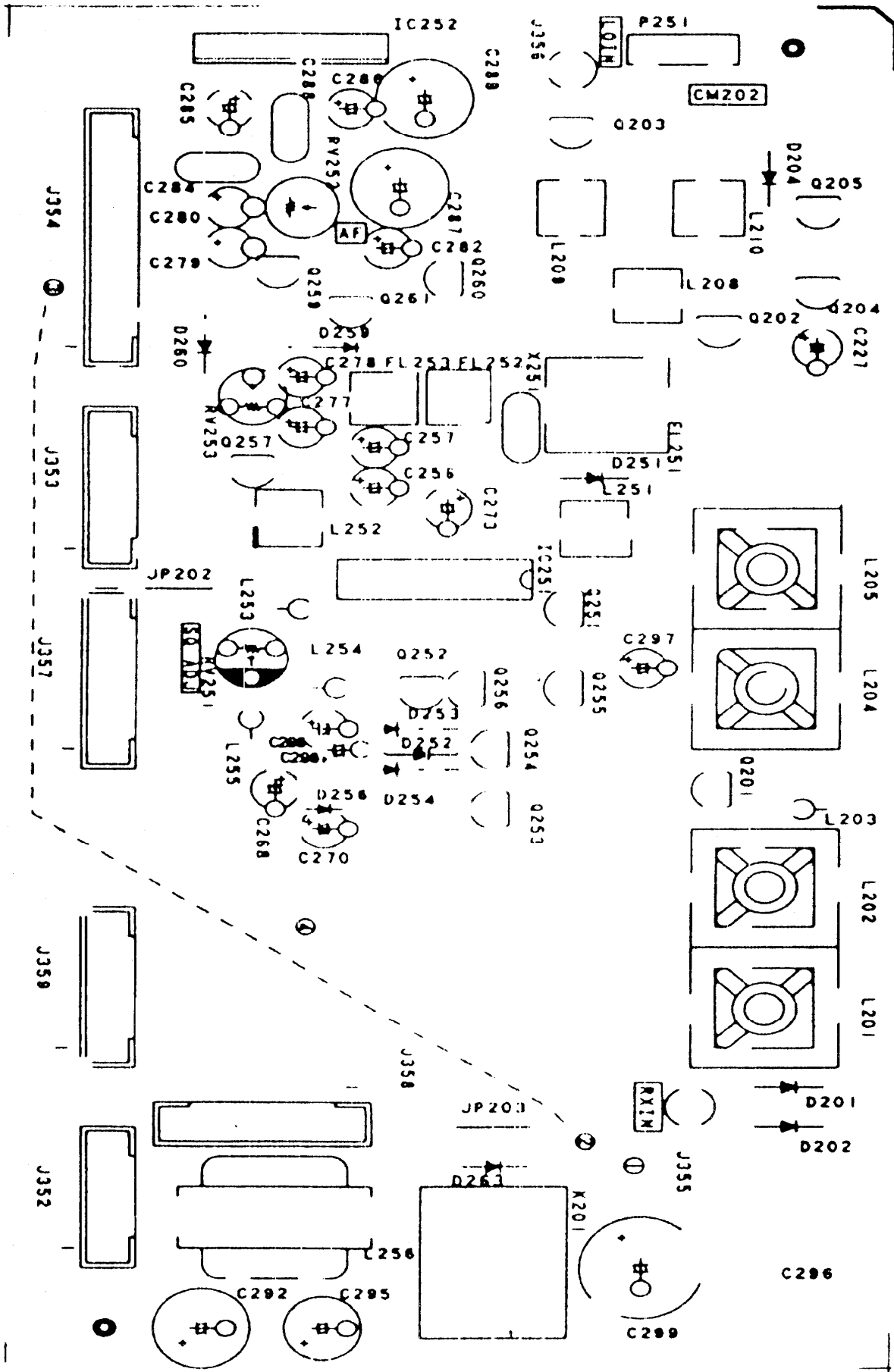



**RT85 Receiver Board Bottom Capacitor View - below:**

